

Introduction to OSPF



ISP Training Workshops

OSPF

- ❑ Open Shortest Path First
- ❑ Link state or SPF technology
- ❑ Developed by OSPF working group of IETF (RFC 1247)
- ❑ OSPFv2 standard described in RFC2328
- ❑ Designed for:
 - TCP/IP environment
 - Fast convergence
 - Variable-length subnet masks
 - Discontiguous subnets
 - Incremental updates
 - Route authentication
- ❑ Runs on IP, Protocol 89

Link State

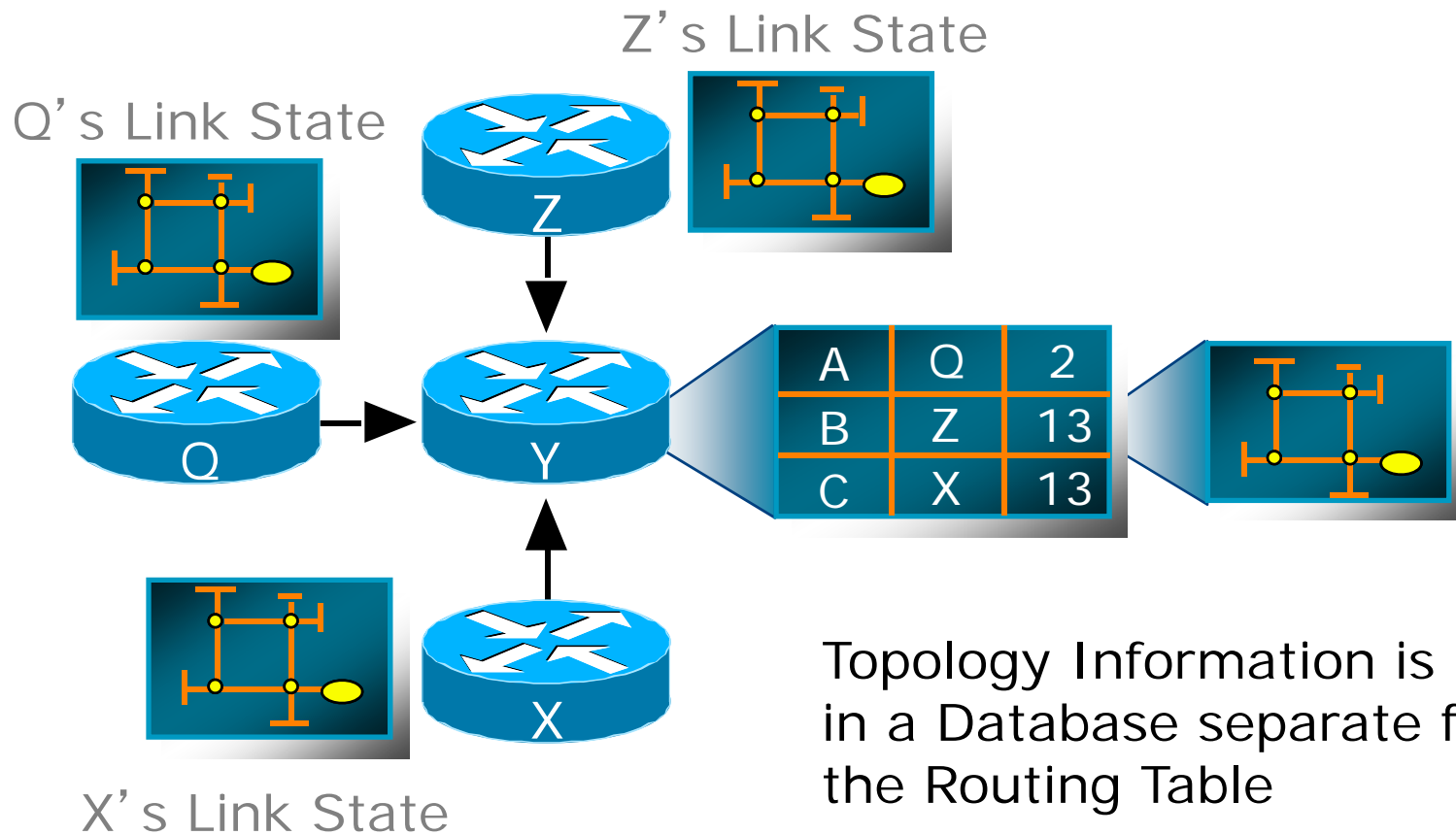

Link State Routing

- ❑ Neighbour discovery
- ❑ Constructing a Link State Packet (LSP)
- ❑ Distribute the LSP
 - (Link State Announcement – LSA)
- ❑ Compute routes
- ❑ On network failure
 - New LSPs flooded
 - All routers recompute routing table

Low Bandwidth Utilisation

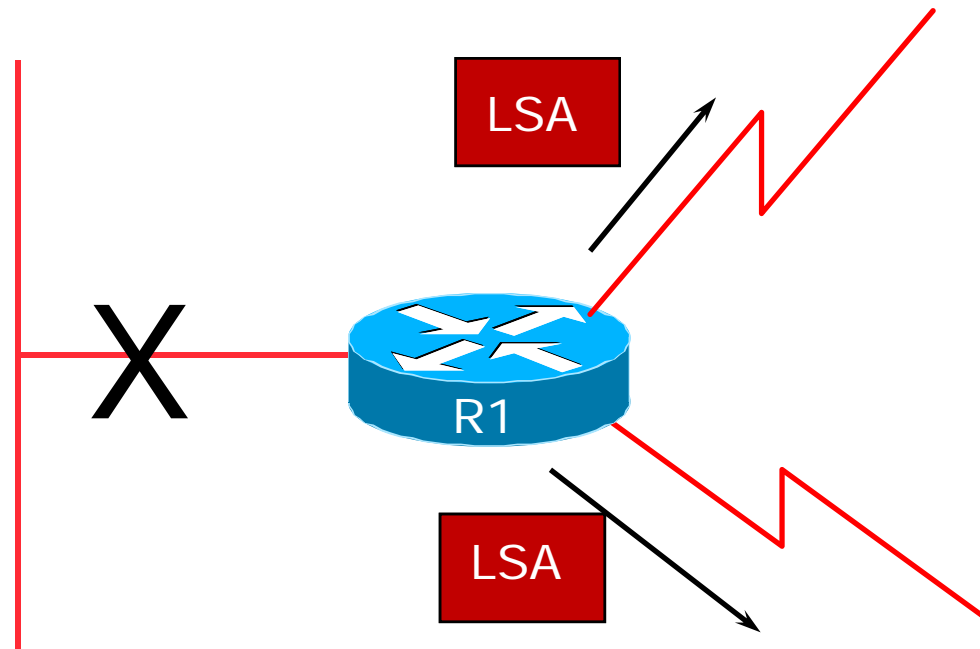

- ❑ Only changes propagated
- ❑ Uses multicast on multi-access broadcast networks

Fast Convergence

- Detection Plus LSA/SPF
 - Known as the Dijkstra Algorithm

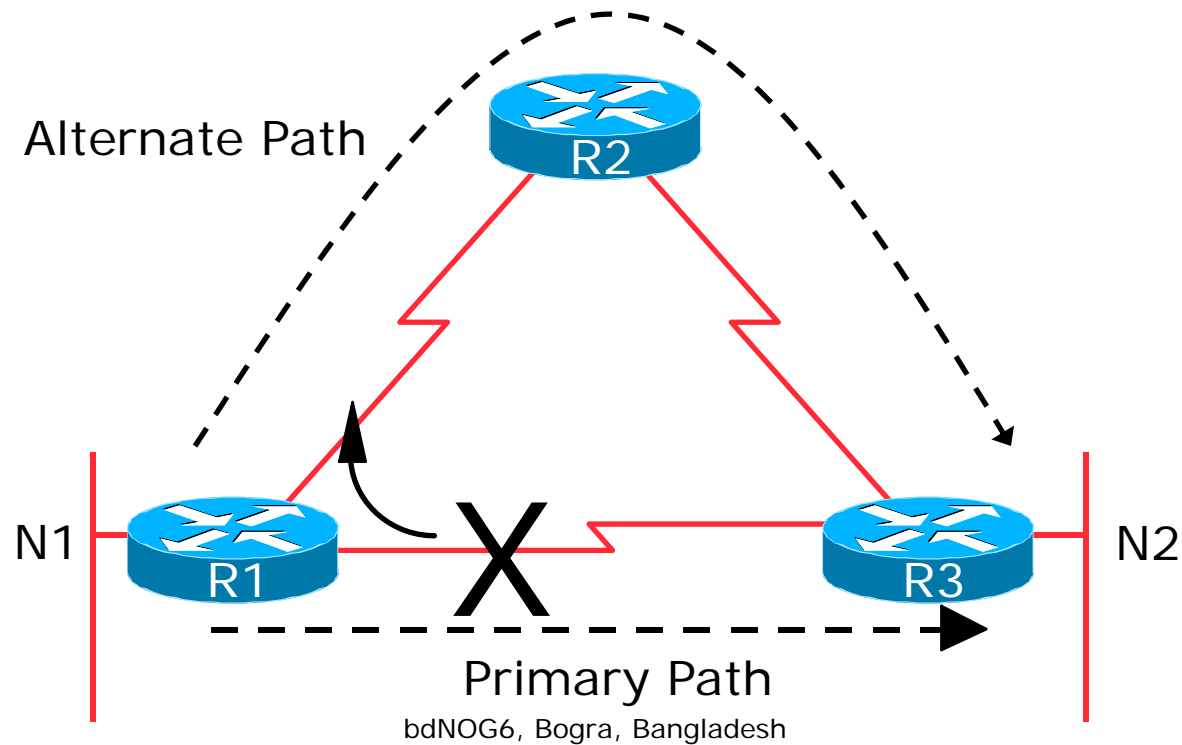

bdNOG6, Bogra, Bangladesh

Fast Convergence

- Finding a new route
 - LSA flooded throughout area
 - Acknowledgement based
 - Topology database synchronised
 - Each router derives routing table to destination network

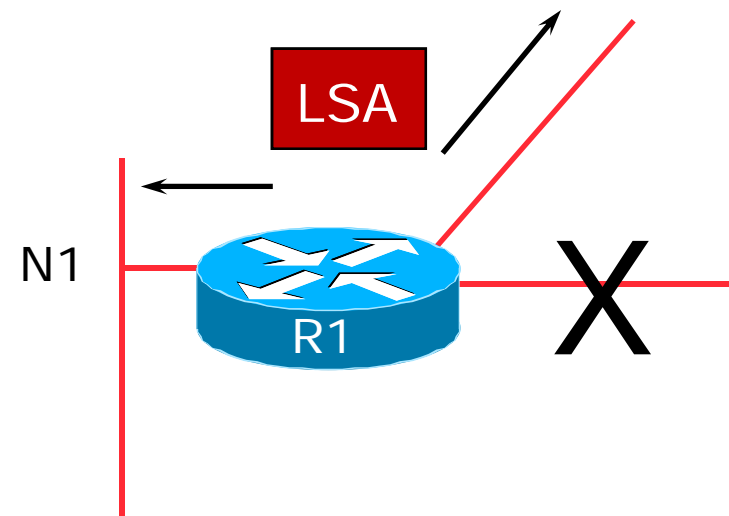

OSPF Areas

- Area is a group of contiguous hosts and networks
 - Reduces routing traffic
- Per area topology database
 - Invisible outside the area
- Backbone area **MUST** be contiguous
 - All other areas must be connected to the backbone

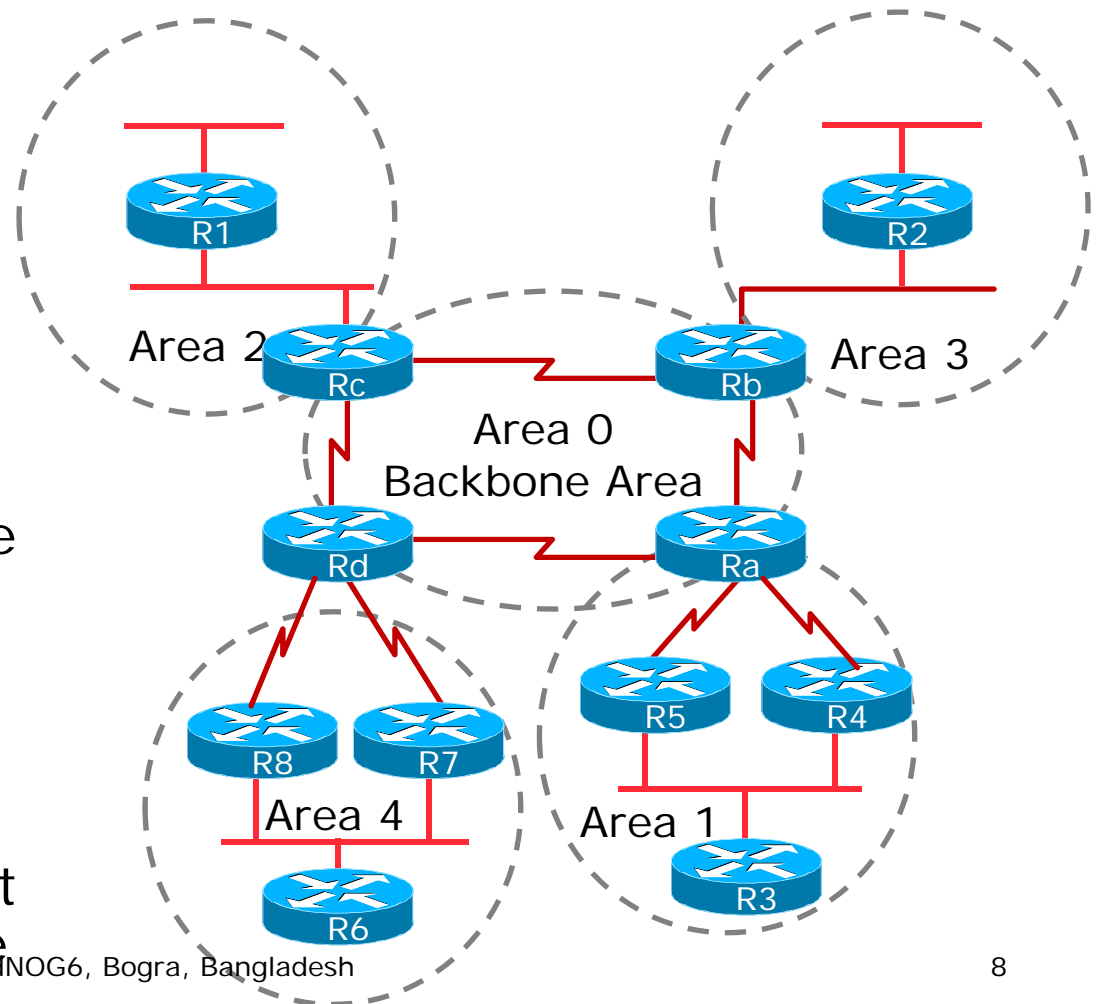

Virtual Links between OSPF Areas

- ❑ Virtual Link is used when it is not possible to physically connect the area to the backbone
- ❑ **ISPs avoid designs which require virtual links**
 - Increases complexity
 - Decreases reliability and scalability

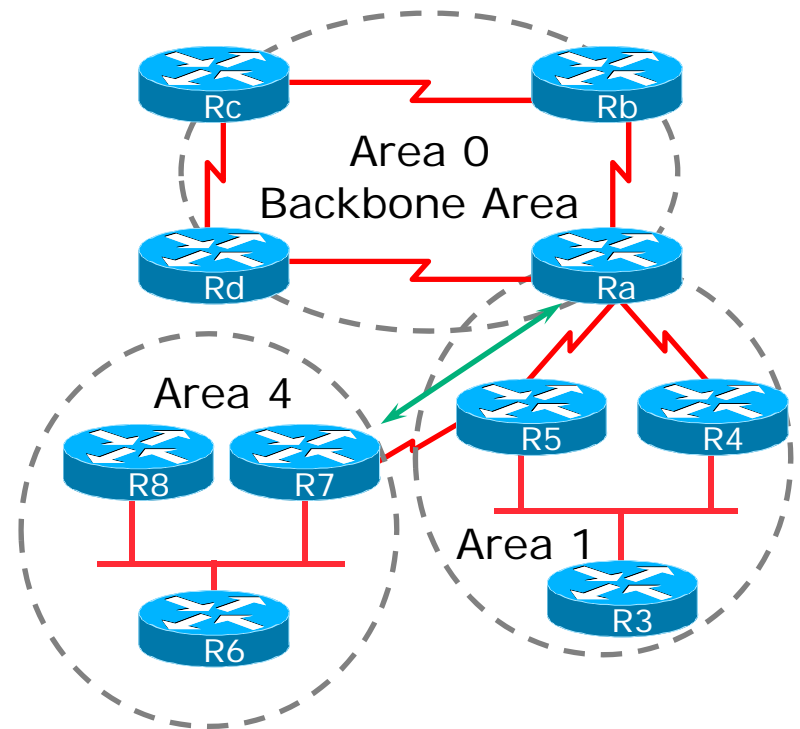

Classification of Routers

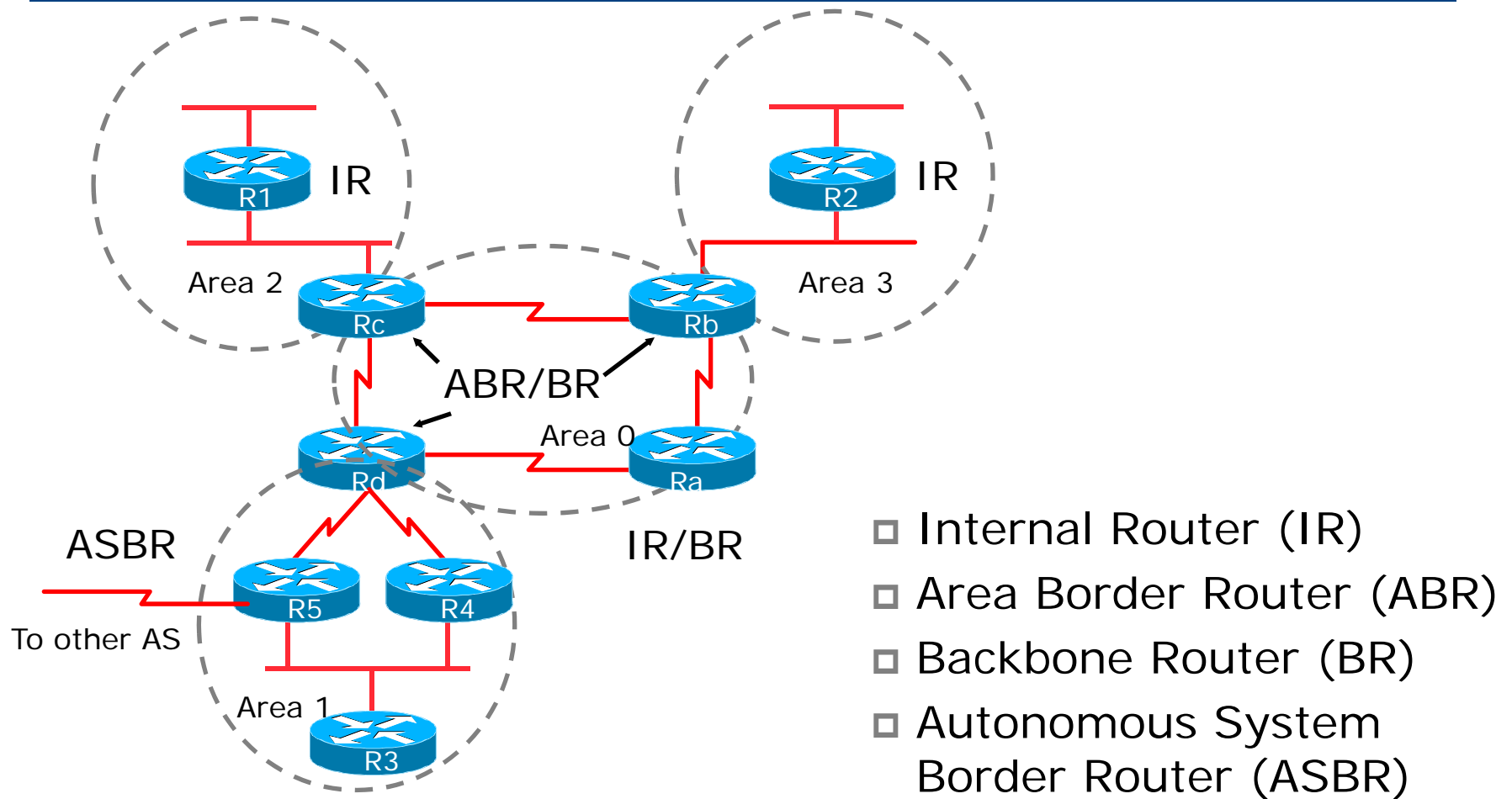

OSPF Route Types

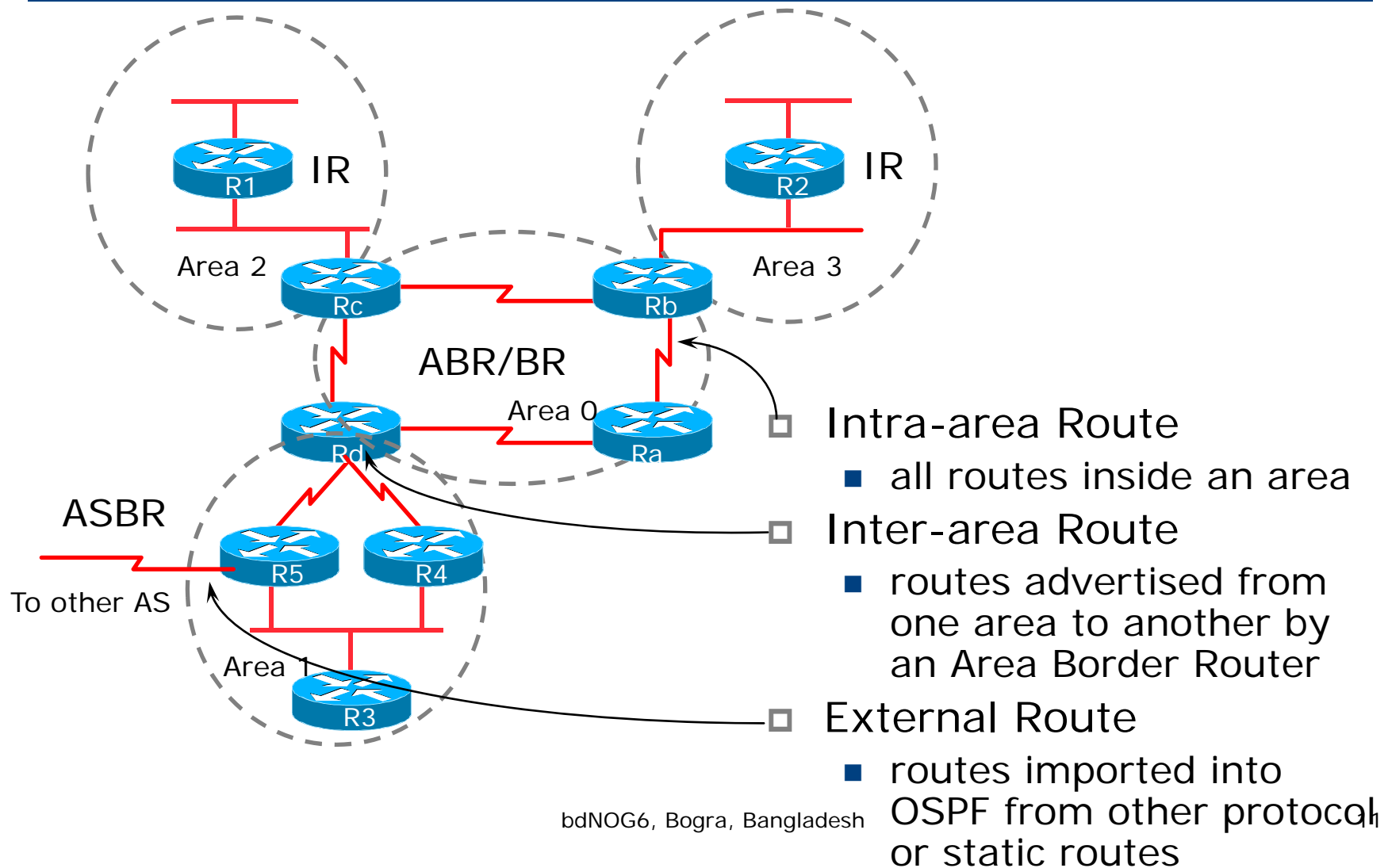

External Routes

- ❑ Prefixes which are redistributed into OSPF from other protocols
- ❑ Flooded unaltered throughout the AS
 - **Recommendation: Avoid redistribution!!**
- ❑ OSPF supports two types of external metrics
 - Type 1 external metrics
 - Type 2 external metrics (Cisco IOS default)

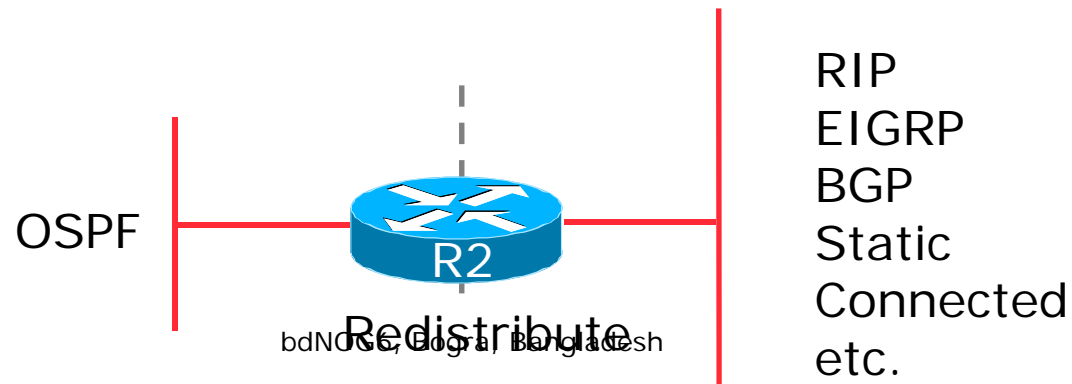

External Routes

- Type 1 external metric: metrics are added to the summarised internal link cost

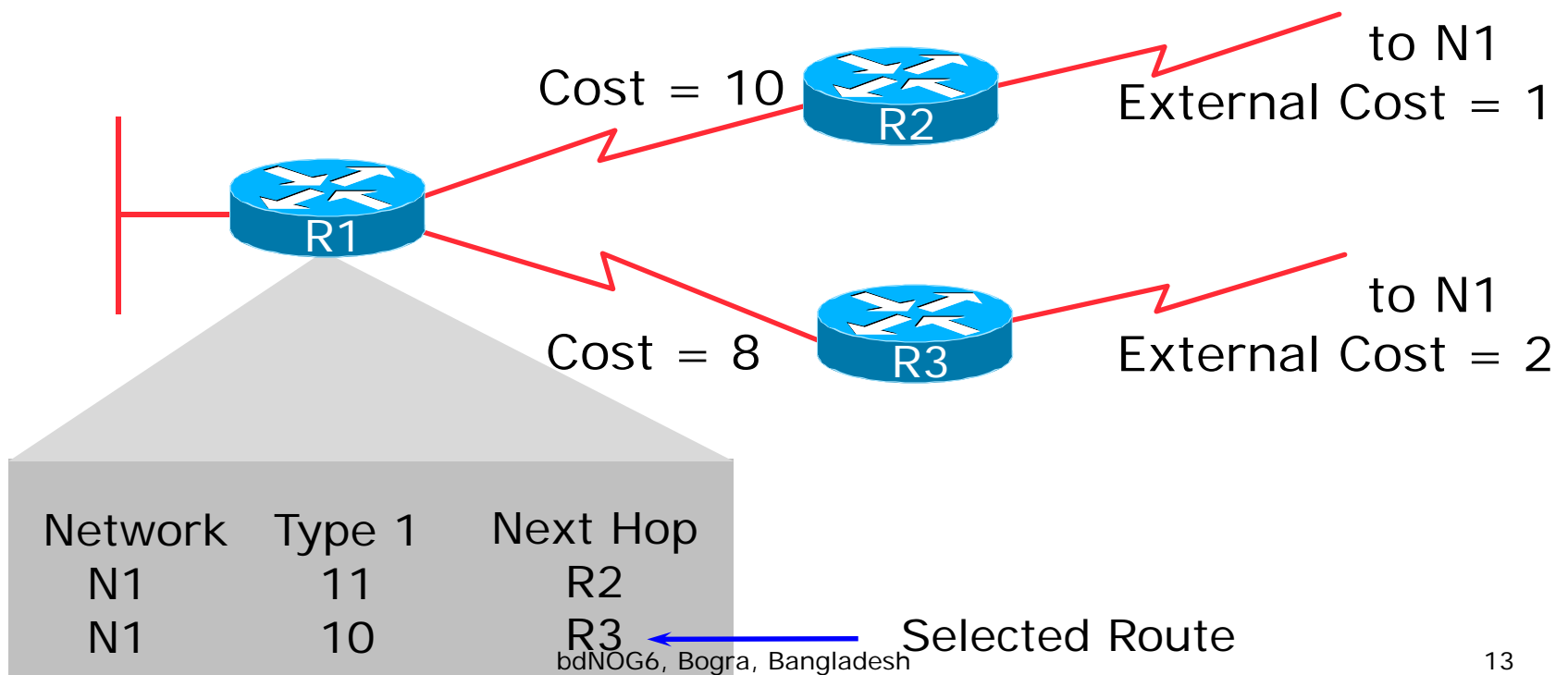

External Routes

- Type 2 external metric: metrics are compared without adding to the internal link cost

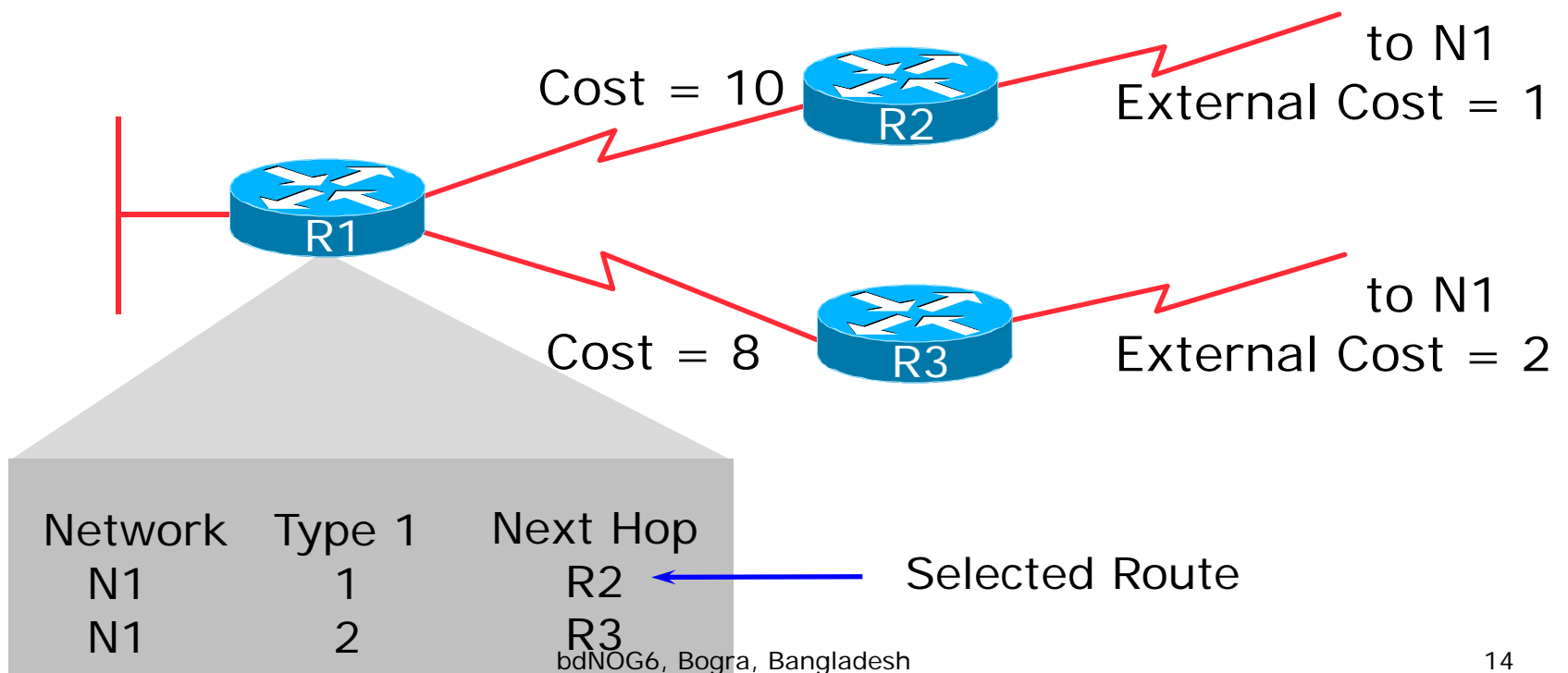

Topology/Link State Database

- ❑ A router has a separate LS database for each area to which it belongs
- ❑ All routers belonging to the same area have identical database
- ❑ SPF calculation is performed separately for each area
- ❑ LSA flooding is bounded by area
- ❑ Recommendation:
 - Limit the number of areas a router participates in!!
 - 1 to 3 is fine (typical ISP design)
 - >3 can overload the CPU depending on the area topology complexity

The Hello Protocol

- Responsible for establishing and maintaining neighbour relationships
- Elects designated router on multi-access networks

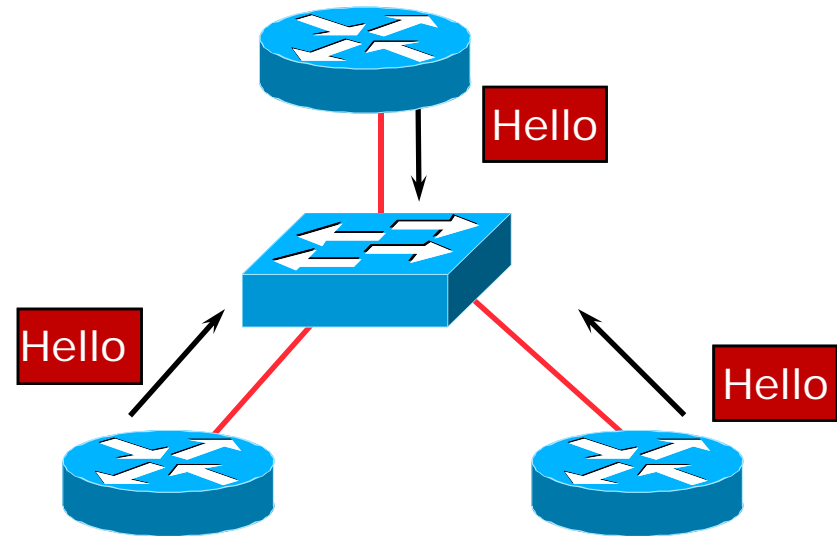

The Hello Packet

- Contains:
 - Router priority
 - Hello interval
 - Router dead interval
 - List of neighbours
 - DR and BDR

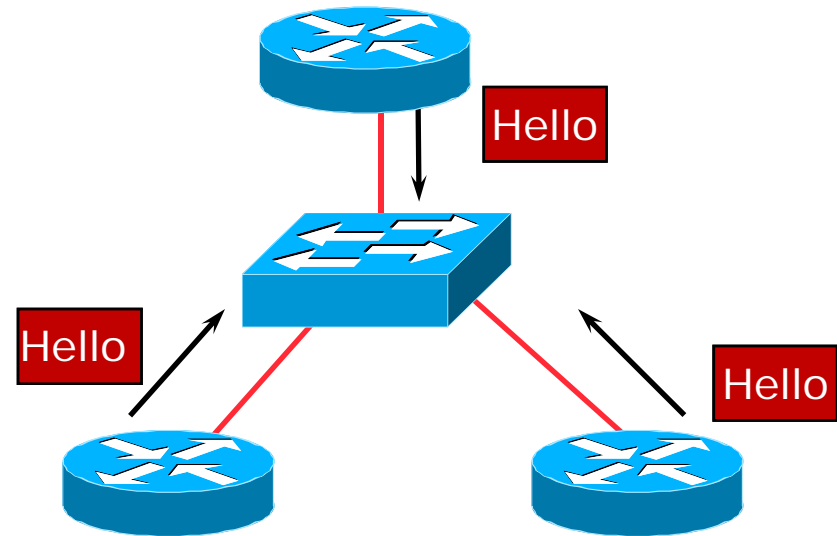

Designated Router

- There is ONE designated router per multi-access network
 - Generates network link advertisements
 - Assists in database synchronization

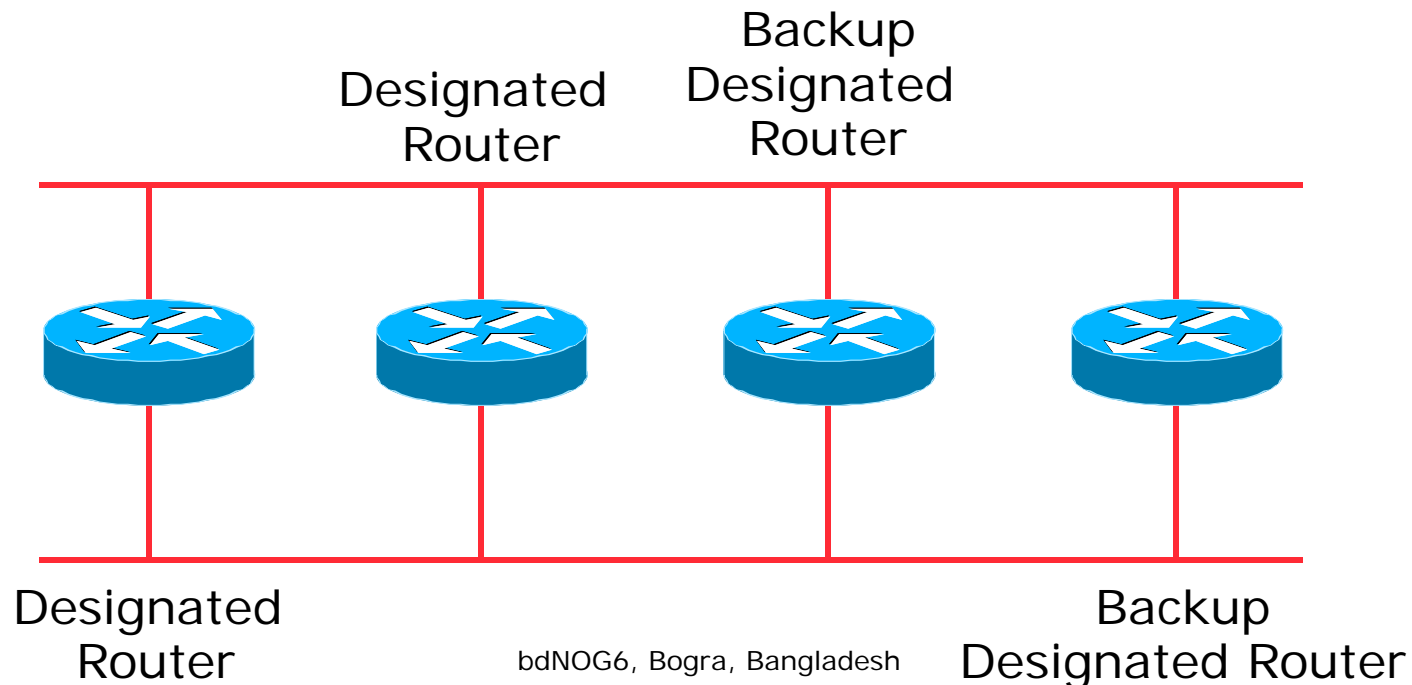

Designated Router by Priority

- ❑ Configured priority (per interface)
 - ISPs configure high priority on the routers they want as DR/BDR
- ❑ Else determined by highest router ID
 - Router ID is 32 bit integer
 - Derived from the loopback interface address, if configured, otherwise the highest IP address

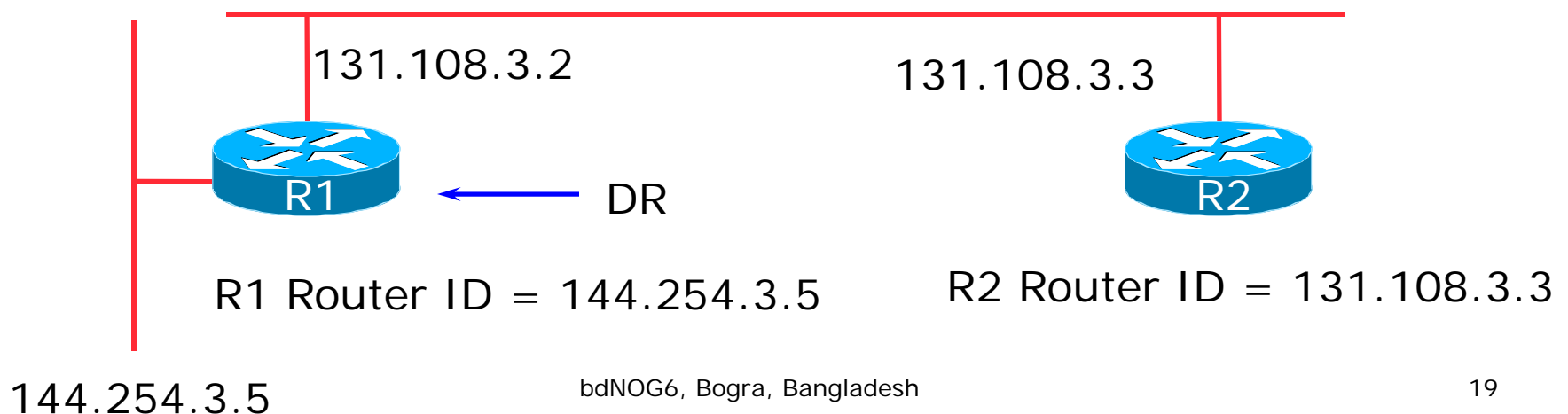

Neighbouring States

□ Full

- Routers are fully adjacent
- Databases synchronised
- Relationship to DR and BDR

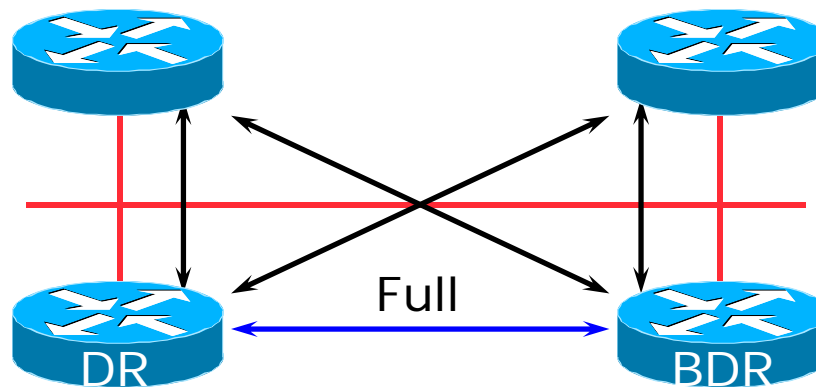

Neighbouring States

□ 2-way

- Router sees itself in other Hello packets
- DR selected from neighbours in state 2-way or greater

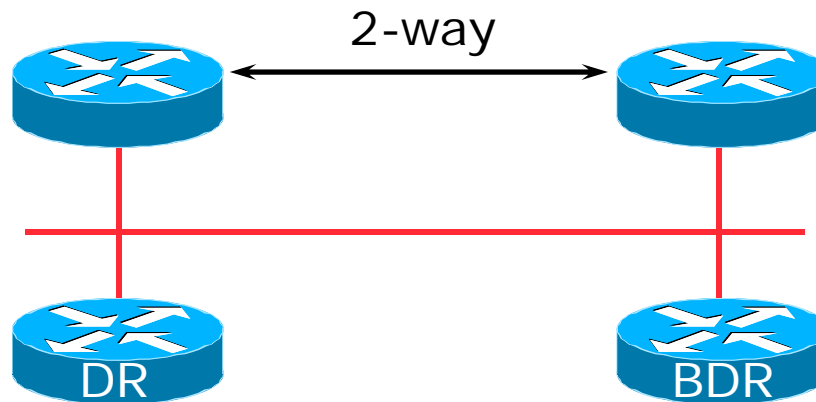

When to Become Adjacent

- ❑ Underlying network is point to point
- ❑ Underlying network type is virtual link
- ❑ The router itself is the designated router or the backup designated router
- ❑ The neighbouring router is the designated router or the backup designated router

LSAs Propagate Along Adjacencies

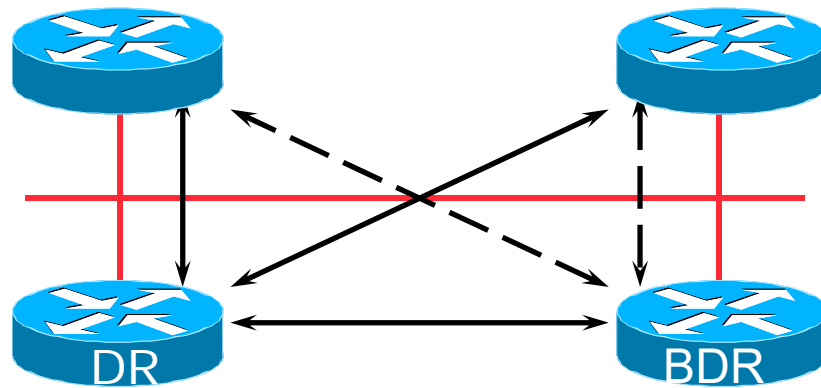

- LSAs acknowledged along adjacencies

Broadcast Networks

- IP Multicast used for Sending and Receiving Updates
 - All routers must accept packets sent to AllSPFRouters (224.0.0.5)
 - All DR and BDR routers must accept packets sent to AllDRouters (224.0.0.6)
- Hello packets sent to AllSPFRouters (Unicast on point-to-point and virtual links)

Routing Protocol Packets

- ❑ Share a common protocol header
- ❑ Routing protocol packets are sent with type of service (TOS) of 0
- ❑ Five types of OSPF routing protocol packets
 - Hello – packet type 1
 - Database description – packet type 2
 - Link-state request – packet type 3
 - Link-state update – packet type 4
 - Link-state acknowledgement – packet type 5

Different Types of LSAs

□ Six distinct type of LSAs

- Type 1 : Router LSA
- Type 2 : Network LSA
- Type 3 & 4: Summary LSA
- Type 5 & 7: External LSA (Type 7 is for NSSA)
- Type 6: Group membership LSA
- Type 9, 10 & 11: Opaque LSA (9: Link-Local, 10: Area)

Router LSA (Type 1)

- ❑ Describes the state and cost of the router's links to the area
- ❑ All of the router's links in an area must be described in a single LSA
- ❑ Flooded throughout the particular area and no more

Network LSA (Type 2)

- ❑ Generated for every transit broadcast and NBMA network
- ❑ Describes all the routers attached to the network
- ❑ Only the designated router originates this LSA
- ❑ Flooded throughout the area and no more

Summary LSA (Type 3 and 4)

- ❑ Describes the destination outside the area but still in the AS
- ❑ Flooded throughout a single area
- ❑ Originated by an ABR
- ❑ Only inter-area routes are advertised into the backbone
- ❑ Type 4 is the information about the ASBR

External LSA (Type 5 and 7)

- ❑ Defines routes to destination external to the AS
- ❑ Default route is also sent as external
- ❑ Two types of external LSA:
 - E1: Consider the total cost up to the external destination
 - E2: Considers only the cost of the outgoing interface to the external destination
- ❑ (Type 7 LSAs used to describe external LSA for one specific OSPF area type)

Types of Areas

- ❑ Regular
- ❑ Stub
- ❑ Totally Stubby
- ❑ Not-So-Stubby
- ❑ **Only “regular” areas are useful for ISPs**
 - Other area types handle redistribution of other routing protocols into OSPF – ISPs don’t redistribute anything into OSPF
- ❑ The next slides describing the different area types are provided for information only

ISP Use of Areas

- ISP networks use:
 - Backbone area
 - Regular area
- Backbone area
 - Or transit area
- Regular area
 - Other than transit area

Addressing for Areas

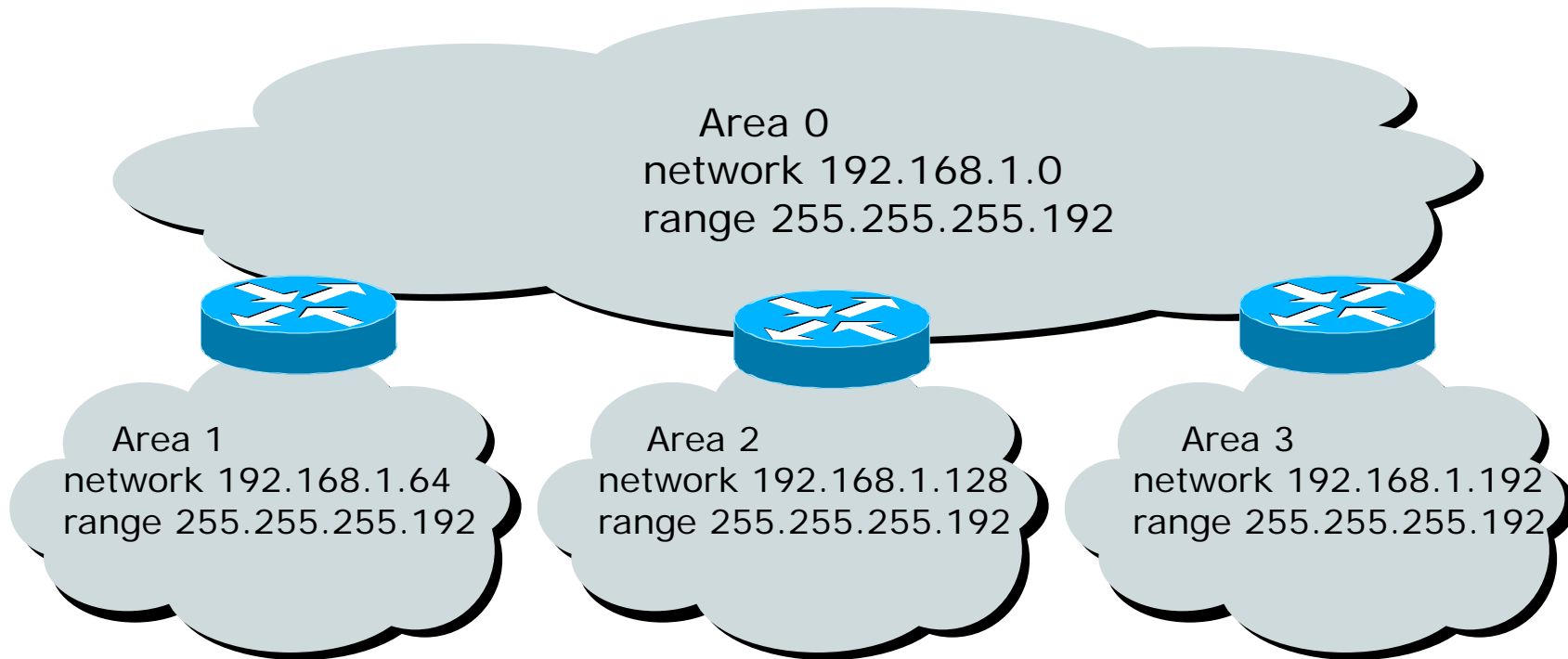

- ▣ Assign contiguous ranges of subnets per area to facilitate summarisation

Summary

- Fundamentals of Scalable OSPF Network Design
 - Area hierarchy
 - DR/BDR selection
 - Contiguous intra-area addressing
 - Route summarisation
 - Infrastructure prefixes only

Introduction to OSPF



ISP Training Workshops